



**Umbra[®]
Pompe**

Your ideal partner since 1984



MP - SP



**Umbra[®]
Pompe**

...your ideal partner





Umbra[®] Pompe

...your ideal partner

L'Azienda fondata nel 1984, proseguendo la precedente storica attività, si è subito affermata quale azienda costruttrice di elettropompe per i settori domestico, civile e industriale. Una solida qualità, unita ad un prezzo interessante ne hanno permesso l'affermazione nei mercati esteri.

Company. Established in 1984, carrying on the previous historical activity it made itself right away known as a manufacturer of submersible pumps for domestic, civil and industrial applications. A strong quality together with a good price made it known on the foreign markets.

Société fondée en 1984, poursuivant l'activité historique précédente elle s'est tout de suite affirmée comme maison constructrice d'électropompes pour les secteurs domestique-civil-industriel. Une solide qualité, unie à un prix intéressant en a permis l'affirmation sur les marchés étrangers.



La Umbra Pompe s.r.l. sorge su di un'area di 10.000 mq. di cui 5.500 coperti.

Umbra Pompe s.r.l. is located in an area of 10.000 mq., 5.500 of them are covered.

Umbra Pompe s.r.l. se dresse sur un terrain de 10.000 mq. dont 5.500 sont couverts.

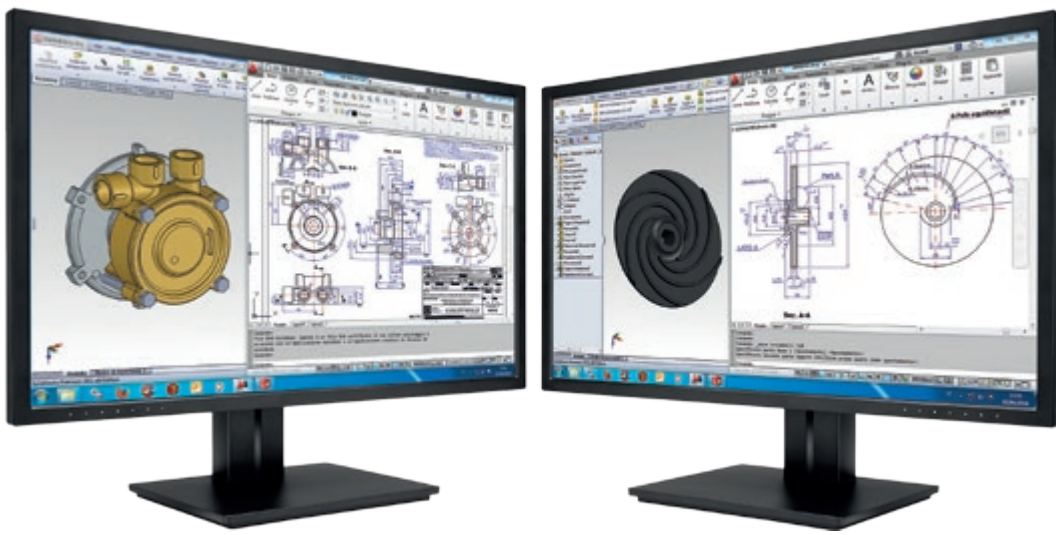

Progettiamo ogni nostra elettropompa utilizzando strumenti all'avanguardia, 30 anni di esperienza e tutta la nostra creatività.

We design all our products using cutting-edge tools, 30 years of experience and all our creativity.

Nous concevons tous nos produits en utilisant des outils de pointe, 30 ans d'expérience et toute notre créativité.



Selezioniamo e testiamo materiali e componentistica di prima qualità.

We select and test first quality materials and components.

Nous sélectionnons et testons tous matériaux et composants de première qualité.



Costruiamo le nostre elettropompe con l'aiuto di macchine ad altissima precisione.

We build our electrical pumps using high-precision machines.

Nous construisons nos électropompes avec l'aide de machines de haute précision.



Umbra[®] Pompe

...your ideal partner



Le mani e gli occhi dell' uomo sono insostituibili nelle fasi di finitura e controllo dell'elettropompa.

Man's hands and eyes are irreplaceable when finishing and checking the electrical pump.

Les mains et les yeux sont irremplaçable en phase de finition et contrôle de l'électropompe.



Controllo estetico imballaggio ed etichettatura sono una fase importantissima per garantire la qualità del prodotto.

Aesthetical control of packaging and labelling is a very important step to guarantee a quality product.

Contrôle esthétique de l'emballage et d'étiquetage sont une phase très important pour garantir la qualité du produit.



Grazie all'efficienza del nostro ciclo produttivo siamo in grado di garantire massima puntualità nelle consegne e nell'assistenza post-vendita.

Thanks to the efficiency of our production cycle we are able to guarantee max punctuality on deliveries and on after sale service.

Grâce au rendement de notre cycle productif nous sommes à même de garantir la maximum de ponctualité dans les livraisons et dans le service après vente.

La Qualità del prodotto è garantita dal pieno rispetto della normativa CE.

The product's **quality** is ensured by satisfying all CE requirements.

La qualité du produit est assurée par la conformité à la directive CE.



CERTIFICATO

Si attesta che / This is to certify that
IL SISTEMA QUALITÀ DI
THE QUALITY SYSTEM OF

UMBRA POMPE S.r.l.

SEDE LEGALE E OPERATIVA:
VIA MATTEOTTI 16
LOCALITÀ SOCCORSO
I-06063 MAGIONE (PG)

È CONFORME AI REQUISITI DELLA NORMA
HAS BEEN FOUND TO COMPLY WITH THE REQUIREMENTS OF

Questo certificato è valido per il seguente campo di applicazione
This certificate is valid for the following product or service range

Progettazione, sviluppo, fabbricazione e commercializzazione di pompe idrauliche sommerse, sommergibili e di superficie (AF-18, 29a)
Design, development, manufacture and trade of submersed, submersible and surface hydraulic pumps (AF-18, 29a)



Per l'Organismo di Certificazione
For the Certification Body
TÜV Italia S.r.l.

Data di emissione / Issue date

02009-0001 ISO 9001:2015
02009-0002 ISO 9001:2015
02009-0003 ISO 9001:2015
02009-0004 ISO 9001:2015

02009-0005 ISO 9001:2015
02009-0006 ISO 9001:2015
02009-0007 ISO 9001:2015
02009-0008 ISO 9001:2015

Data di scadenza / Expiry date

Organizzazione certificata per la prima volta in data

"La validità del presente certificato è subordinata a sorveglianza periodica a 12 mesi e al riesame completo del sistema di gestione aziendale con periodicità triennale"
"The validity of the present certificate depends on the annual surveillance every 12 months and on the complete review of company's management system after three years"

TÜV Italia S.r.l. • Gruppo TÜV SÜD • Via Carducci 125, Pal. 23 • 20099 Sesto San Giovanni (MI) • Italia • www.tuv.it TÜV®

La qualità del sistema di gestione viene assicurata secondo quanto prescritto dalla norma UNI EN ISO 9001:2015.

The system's quality is ensured by the UNI EN ISO 9001:2015

The system's quality is ensured by the UNI EN ISO 9001:2015

La qualité du système est assuré selon la norme UNI EN ISO 9001:2015.

EAC

Certification CU TR

Tutti i prodotti Umbra Pompe sono conformi alle normative europee di sicurezza, ottenendo anche le più severe certificazioni internazionali.

All Umbra Pompe products satisfy the European directive on safety requirements, obtaining even the strictest international certifications.

Tous les produits Umbra Pompe sont conformes aux normes européennes de sécurité, en obtenant aussi les plus sévères certifications internationales.

Elettropompe centrifughe multicellulari - Centrifugal multistage electrical pumps
Électropompes centrifuges multicellulaires



MADE IN ITALY



Impieghi

Elettropompe centrifughe pluristadio con giranti radiali chiuse studiate per risolvere tutti i problemi di convogliamento di acque pulite con temperature che non superino 35°C. Max contenuto di sabbia 60 gr/m. Max numero avviamenti ora 40. Particolarmente indicata per irrigazioni, impianti di pressurizzazione, usi industriali e civili in genere, recupero acque piovane. Adatta uso continuo.

Caratteristiche costruttive

Realizzate con materiali inossidabili di primissima qualità sottoposte a severi controlli elettrici ed idraulici. Estrema facilità di riparazione. Nella versione monofase il condensatore è inserito all'interno della pompa. MP non autode-scante. SP autode-scante.

Materiali

Corpo pompa MP ghisa, SP ottone, carcassa motore in INOX AISI 304. Giranti, diffusori, separatori in PPO caricato vetro, ogni stadio è completo di anello antiusura in acciaio inox. Albero motore in INOX AISI 420. Tenuta meccanica in allumina-grafite. A richiesta in CARBURO di SILICIO. Guarnizioni in NBR.

Motore

Asincrono monofase 230V. 50 HZ o Trifase 400V. 50 HZ. Altre tensioni e frequenze a richiesta. Classe d'isolamento F, IP 44. Protezione termica incorporata.

Applications

Centrifugal multistage electrical pump with centrifugal radial impellers. Designed to handle clean water at a maximum temperature of 35 deg. C. Max numbers of intervention 40/h. Max content of sand 60 gr/m. Particularly suited for irrigation, water boosting, water transfer, other water duties for both civil and industrial applications, rainwater collection. Suitable for continuous service.

Specifications

Manufactured in Stainless Steel to the highest quality and standards, following extensive electrical and hydraulic tests. They are easy to dismantle for repair and cleaning. Single phase version are supplied with built-in capacitor. MP not self-priming. SP self-priming.

Materials

Pump MP cast iron, SP brass, motor body AISI 304. Impellers, diffusers and separators in re-inforced PPO. Each pump stage is fitted with a Stainless Steel ring for wear resistance. The motor shaft is in Stainless Steel AISI 420. The mechanical seal is Alumina/Graphite, (Silicone Carbide seal available on request). Packing in NBR.

Motor

Asynchronous, single phase 230V-50 HZ or three phase, 400V-50HZ. Other voltages or frequencies available on request. Insulation Class F, IP 44. Built-in overload protection.

Emplois

Pompes électriques centrifuges à plusieurs étages avec turbines radiales fermées étudiées pour résoudre tous les problèmes de pompage des eaux claires à température maximale de 35° C. Nombres max de démarrage 40/h. Contenu max de sable 60 gr/m. Particulièrement indiquées pour l'irrigation, les installation de présurisation, usages industriels et civils en général, récupérer l'eau de pluie. Apte pour usage continu.

Caractéristiques techniques

Réalisées avec des matériaux inoxydables de première qualité, soumises à des contrôles électriques et hydrauliques sévères. Dans la version monophasée le condensateur est inséré à l'intérieur de la pompe. MP amorçage non automatique. SP amorçage automatique.

Matériaux

Corps de pompe MP fonte, SP laiton, carcasse moteur inox AISI 304. Turbines, diffuseurs et séparateurs en PPO renforcé. Chaque étage est muni d'un anneau antiusura en acier inox. Arbre moteur en acier inox AISI 420. Garniture mécanique en alumine/graphite lubrifiée avec huile. Sur demande en carbure de silicium. Garniture en NBR.

Moteur

Asynchrone-monophasé 230V-50HZ ou triphase 400V. 50HZ. Autres tensions et fréquences sur demande. Classe d'isolation F, IP 44. Protection thermique incorporée.

Caratteristiche e dimensioni

Specifications and dimensions

Caractéristiques et dimensions

Tolleranze e prestazioni:
EN ISO 9906 Annex A1 level 2

Costruzioni secondo norme:
CEI EN 60335-1, 60335-2-41
EN 55014-1, 55014-2
EN 61000-3-2, 61000-3-3

Tolerances and performances as per:
EN ISO 9906 Annex A1 level 2

Construction as per:
CEI EN 60335-1, 60335-2-41
EN 55014-1, 55014-2
EN 61000-3-2, 61000-3-3

Construction selon les normes:
EN 60 335-2-41 (CEI 61-69)

Tolérances et performances selon:
CEI EN 60335-1, 60335-2-41
EN 55014-1, 55014-2
EN 61000-3-2, 61000-3-3

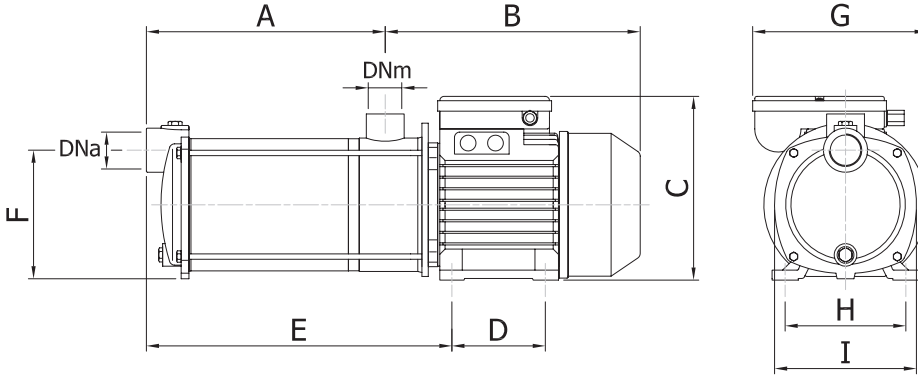

Type	A mm	B mm	C mm	D mm	E mm	F mm	G mm	H mm	I mm	DN a	DN m	Peso Kg
3 - 95	175	235	175	90	243	125	166	112	135	1"	1"	10
4 - 95	199	235	175	90	267	125	166	112	135	1"	1"	11
5 - 95	223	235	175	90	291	125	166	112	135	1"	1"	12
3 - 120	175	235	175	90	243	125	166	112	135	1"	1"	10
4 - 120	199	235	175	90	267	125	166	112	135	1"	1"	11
5 - 120	223	235	175	90	291	125	166	112	135	1"	1"	12



N° pompe per pallet
N° pumps per pallet
N° pompes pour palette
pag. 66

Curve di funzionamento 50 Hz - 2850 rpm

Operating curves 50 Hz - 2850 rpm

Courbes de fonctionnement 50 Hz - 2850 rpm

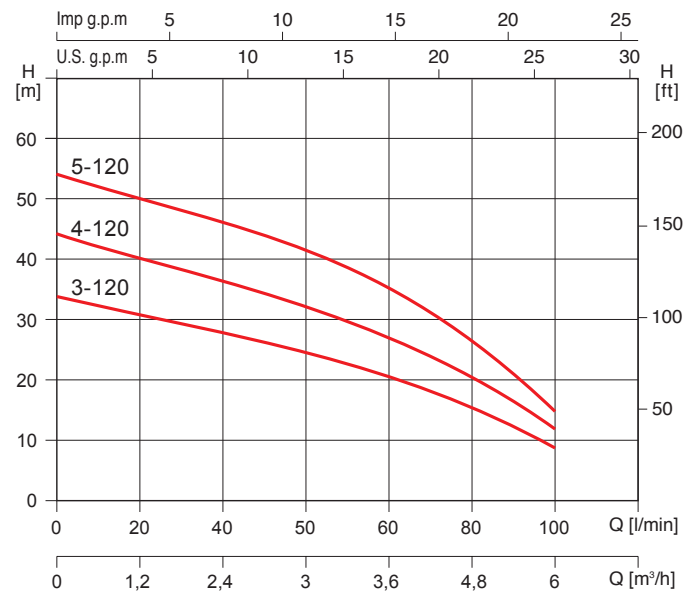
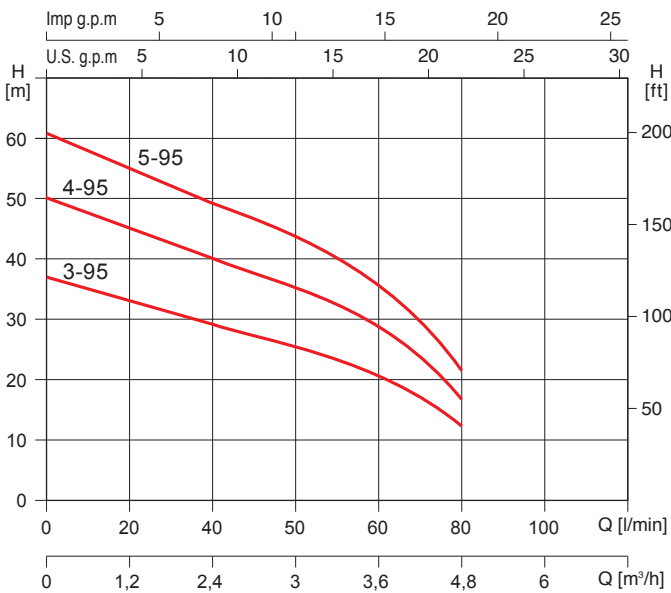

Tipo Type	P2		P1 KW ¹	Ampere			Q m ³ /h L/min	Portata - Delivery - Debit								
	HP	KW		230 V. 50 Hz	400 V. 50 Hz	µF		0	0,6	1,2	1,6	2,4	3,6	4,2	4,8	5,7
3 - 95	0,75	0,55	0,9	4,5	1,6	16	Hm	35	34	33	31	28	21	18	13	0
4 - 95	1	0,75	1,05	5	2,2	20	Hm	50	47	44	42	40	29	24	15	0
5 - 95	1,2	0,9	1,25	6,2	2,3	20	Hm	63	58	55	52	48	36	29	21	0

Tipo Type	P2		P1 KW ¹	Ampere			Q m ³ /h L/min	Portata - Delivery - Debit								
	HP	KW		230 V. 50 Hz	400 V. 50 Hz	µF		0	1,2	2,4	3	3,6	4,8	8	7,2	
3 - 120	0,9	0,67	1	4,8	1,8	16	Hm	34	30	26	24	21	15	8	0	
4 - 120	1,1	0,82	1,25	5,6	2,4	20	Hm	44	39	34	31	28	22	13	0	
5 - 120	1,4	1,05	1,55	7,1	2,5	20	Hm	54	48	46	43	36	27	15	0	

P1 Max potenza assorbita in KW - P1 Max absorbed power in KW - P1 Max puissance absorbée en KW
P2 Potenza nominale in HP e KW - P2 Rated power output in HP and KW - P2 Puissance nominale en HP et KW

Caratteristiche e dimensioni

Specifications and dimensions

Caractéristiques et dimensions

Tolleranze e prestazioni:
EN ISO 9906 Annex A1 level 2

Costruzioni secondo norme:
CEI EN 60335-1, 60335-2-41
EN 55014-1, 55014-2
EN 61000-3-2, 61000-3-3

Tolerances and performances as per:
EN ISO 9906 Annex A1 level 2

Construction as per:
CEI EN 60335-1, 60335-2-41
EN 55014-1, 55014-2
EN 61000-3-2, 61000-3-3

Construction selon les normes:
EN 60 335-2-41 (CEI 61-69)

Tolérances et performances selon:
CEI EN 60335-1, 60335-2-41
EN 55014-1, 55014-2
EN 61000-3-2, 61000-3-3

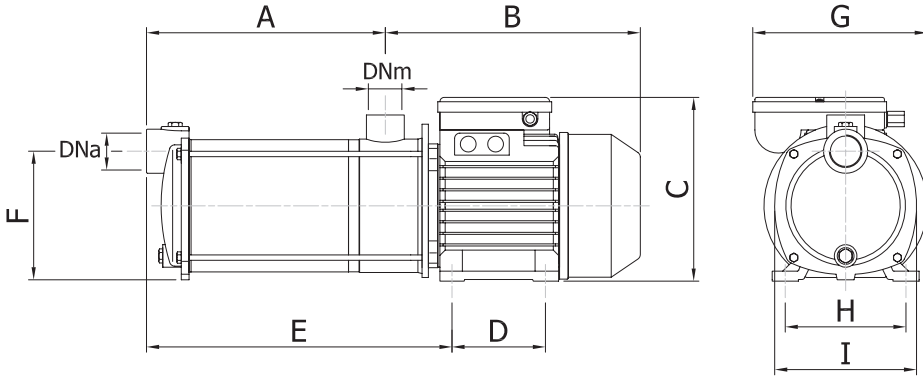

Type	A mm	B mm	C mm	D mm	E mm	F mm	G mm	H mm	I mm	DN a	DN m	Peso Kg
3 - 90	179,5	235	175	90	247	125	166	112	135	1"	1"	10
4 - 90	203,5	235	175	90	271	125	166	112	135	1"	1"	11
5 - 90	227,5	235	175	90	295	125	166	112	135	1"	1"	12
3 - 120	179,5	235	175	90	247	125	166	112	135	1"	1"	10
4 - 120	203,5	235	175	90	271	125	166	112	135	1"	1"	11
5 - 120	227,5	235	175	90	295	125	166	112	135	1"	1"	12



N° pompe per pallet
N° pumps per pallet
N° pompes pour palette
pag. 66

Curve di funzionamento 50 Hz - 2850 rpm

Operating curves 50 Hz - 2850 rpm

Courbes de fonctionnement 50 Hz - 2850 rpm

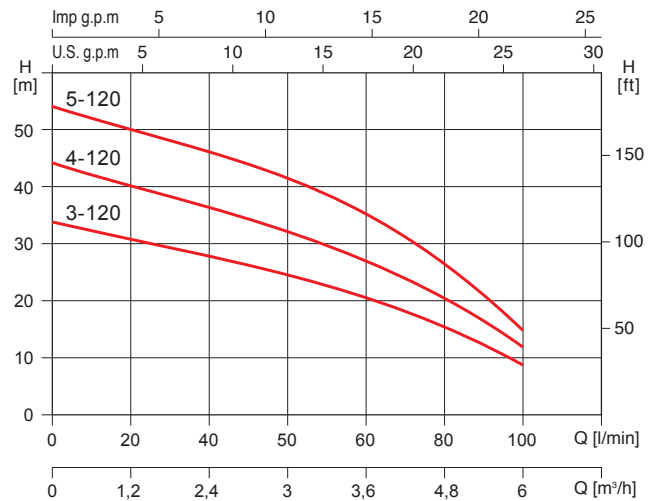
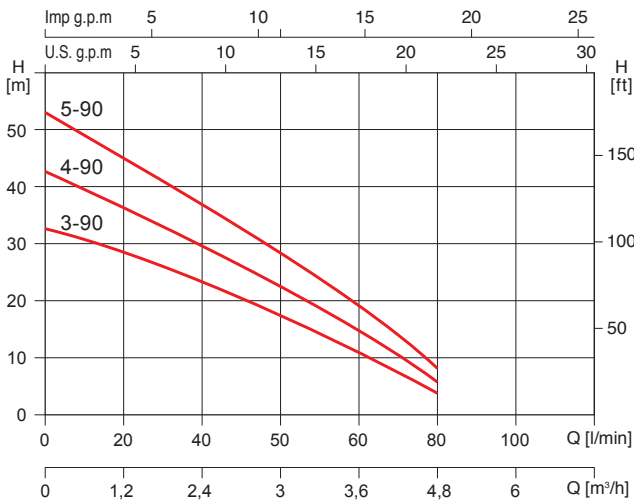

Tipo Type	P2		P1	Ampere		μF	Q m³/h L/min	Portata - Delivery - Debit								
	HP	KW	KW ¹	230 V. 50 Hz	400 V. 50 Hz			0	0,6	1,2	1,6	2,4	3,6	4,2	4,8	5,4
3 - 90	0,75	0,55	0,9	4,3	1,7	16	Hm	32	30	28	25	22	12	7	4	0
4 - 90	1	0,75	1,05	4,9	2	20	Hm	44	40	36	33	28	17	11	5	0
5 - 90	1,2	0,9	1,3	6	2,3	20	Hm	54	48	44	40	34	19	12	5	0

Tipo Type	P2		P1	Ampere		μF	Q m³/h L/min	Portata - Delivery - Debit								
	HP	KW	KW ¹	230 V. 50 Hz	400 V. 50 Hz			0	1,2	2,4	3	3,6	4,8	8	7,2	
3 - 120	0,9	0,67	1	4,8	1,8	16	Hm	34	30	26	24	21	15	8	0	
4 - 120	1,1	0,82	1,25	5,6	2,4	20	Hm	44	39	34	31	28	22	13	0	
5 - 120	1,4	1,05	1,55	7,1	2,5	20	Hm	54	48	46	43	36	27	15	0	

P1 Max potenza assorbita in KW - P1 Max absorbed power in KW - P1 Max puissance absorbée en KW
P2 Potenza nominale in HP e KW - P2 Rated power output in HP and KW - P2 Puissance nominale en HP et KW

3" ACUASPEED (only pump's box without considering inverter)			
Type	TRUCK		CONTAINER
	Pallet (cm) 120x80	Pallet (cm) 115x115	Pallet (cm) 120x100
2 - 55	100	-	120
2 - 85	100	-	120
3 - 55	100	-	120
3 - 80	100	-	120

5" ACUATEC, ACUARAIN LP			
Type	TRUCK		CONTAINER
	Pallet (cm) 120x80	Pallet (cm) 115x115	Pallet (cm) 120x100
30	80	-	120
40	80	-	120
60	80	-	100
70	48	80	-
80	48	80	-
150	80	-	100
160	48	80	-
170	48	80	-

4" EUROJET, ACUAJET, ACUASUB			
Type	TRUCK		CONTAINER
	Pallet (cm) 120x80	Pallet (cm) 115x115	Pallet (cm) 120x100
Mini Eurojet	96	-	120
Eurojet	96	-	120
Acuajet	96	-	120
55/100 1,5 mt	60	-	112
55/100 20 mt	48	-	80 (120x120)
55/140 1,5 mt	60	100	-
55/140 20 mt	32	-	48
100/70 1,5 mt	100	-	128
100/70 20 mt	48	80	-
100/100 1,5 mt	60	-	112
100/100 20 mt	48	-	80 (120x120)









5" ACUABIG			
Type	TRUCK		CONTAINER
	Pallet (cm) 120x80	Pallet (cm) 115x115	Pallet (cm) 120x100
2/200	80	-	100
3/200	48	80	-
4/200	48	-	80 (120x120)
5/200	48	-	80 (120x120)

4" SANDY			
Type	TRUCK		CONTAINER
	Pallet (cm) 120x80	Pallet (cm) 115x115	Pallet (cm) 120x100
55/40 1,5 mt	60	-	128
55/60 1,5 mt	60	110	-
55/100 1,5 mt	60	100	-
55/140 1,5 mt	60	100	-
100/70 1,5 mt	60	-	112
100/100 1,5 mt	60	90	-

ACUARAIN			
Type	TRUCK		CONTAINER
	Pallet (cm) 120x80	Pallet (cm) 115x115	Pallet (cm) 120x100
30	80	-	100
40	80	-	100
60	48	80	-
70	48	-	80 (120x120)
80	48	-	80 (120x120)
150	48	80	-
160	48	-	80 (120x120)
170	48	-	80 (120x120)
2/200	80	-	100
3/200	48	80	-
4/200	48	-	80 (120x120)
5/200	48	-	80 (120x120)

4", 5" ACUAFLUSS, ACUAFLUSS-L, ACUAFLUSS LP			
Type	TRUCK		CONTAINER
	Pallet (cm) 120x80	Pallet (cm) 115x115	Pallet (cm) 120x100
55/60	48	-	84
100/70	48	-	84
30, 30 LP	80	-	100
40, 40 LP	48	80	-
60, 60 LP	48	80	-
30 L	48	80	-
40 L	48	80	-
60 L	48	-	80 (120x120)

ACUASYSTEM 2AL			
Type	TRUCK		CONTAINER
	Pallet (cm) 120x80	Pallet (cm) 115x115	Pallet (cm) 120x100
30	56	-	90
60	42	-	60
80	42	-	60
150	42	-	60
170	42	-	60

Container 20'	Pallet (cm) 120x80	Pallet (cm) 115x115	Pallet (cm) 120x100
	 max 11	 max 10	 max 9
	 max 25	 max 20	 max 22

ACUASYSTEM AC			
Type	TRUCK		CONTAINER
	Pallet (cm) 120x80	Pallet (cm) 115x115	Pallet (cm) 120x100
30	80	-	120
40	80	-	100
60	48	80	-
70	48	80	-
80	60	-	70
150	48	80	-
160	48	80	-
170	60	-	70

ACUASYSTEM mini			
Type	TRUCK		CONTAINER
	Pallet (cm) 120x80	Pallet (cm) 115x115	Pallet (cm) 120x100
mini	120	-	150









ACUA mini			
Type	TRUCK		CONTAINER
	Pallet (cm) 120x80	Pallet (cm) 115x115	Pallet (cm) 120x100
mini	120	-	150

BABY			
Type	TRUCK		CONTAINER
	Pallet (cm) 120x80	Pallet (cm) 115x115	Pallet (cm) 120x100
BABY	120	-	150

ACUA PV GR - A - R			
Type	TRUCK		CONTAINER
	Pallet (cm) 120x80	Pallet (cm) 115x115	Pallet (cm) 120x100
100 GR	60	-	75
120 GR	24	-	48
180 GR	24	-	48
60A / 75A	72	-	120
80A / 80R	60	-	75
100A / 100R	60	-	75
140A / 140R	60	-	75
150A / 150R	24	-	48
200A / 200R	24	-	48
300A	24	-	48

SAL			
Type	TRUCK		CONTAINER
	Pallet (cm) 120x80	Pallet (cm) 115x115	Pallet (cm) 120x100
35/40	144	-	320
35/40 v.48/115	105	-	240
45	105	-	240

MP/SP			
Type	TRUCK		CONTAINER
	Pallet (cm) 120x80	Pallet (cm) 115x115	Pallet (cm) 120x100
all models	63	-	126

Container 20'	Pallet (cm) 120x80	Pallet (cm) 115x115	Pallet (cm) 120x100
	 max 11	 max 10	 max 9
	 max 25	 max 20	 max 22

CONDIZIONI GENERALI DI VENDITA

1) ORDINI: Qualsiasi ordinazione trasmessaci, sia a mezzo di ns/agenti che a mezzo lettera, telefono o fax, si intende definita soltanto dopo ns/regolare accettazione scritta.

2) CONSEGNA: I termini indicati per la consegna non sono impegnativi ma subordinati alle possibilità di fabbricazione o a causa di forza maggiore (agitazioni sindacali, guasti a macchinari, ritardata consegna da parte di fornitori, situazioni generali di irreperibilità di materie prime, incendi, inondazioni od altre cause di forza maggiore). Un eventuale ritardo non può dar luogo da parte dell'acquirente ad annullamento dell'ordine né a pretesa di rifusione di danni.

3) SPEDIZIONE: La merce viaggia a rischio e pericolo del committente anche se il prezzo è stabilito franco destino. Non si risponde di alcun reclamo per mancanza di peso od avarie di viaggio essendo di ciò responsabile solo ed esclusivamente il vettore al quale il destinatario deve prontamente elevare riserva prima di ritirare la merce e di ciò dare comunicazione scritta anche al cessionario per conoscenza. Trascorsi comunque 8 giorni dalla data di ricevimento della merce non sono più ammessi reclami.

4) PREZZI: I prezzi si intendono al netto degli oneri fiscali, possono essere variati senza obbligo di preavviso.

5) RISERVA DI PROPRIETA': La proprietà dei beni consegnati permane al costruttore e non trapassa al cliente se non dopo l'integrale pagamento del prezzo, degli interessi e delle spese dovute. In caso di inadempienza la merce andrà, su espressa richiesta del costruttore, prontamente riconsegnata presso i depositi dal costruttore indicati in porto franco. Il costruttore si riserva comunque la facoltà di addebitare al cliente le spese sostenute per la rigenerazione e messa a nuovo del materiale reso.

6) PAGAMENTI: I pagamenti devono essere effettuati alla scadenza e nei modi convenuti alla ns/sede di Magione (PG). Non sono riconosciuti i pagamenti effettuati ad agenti, rappresentanti od altri anche se a mezzo effetti, salvo espressa autorizzazione scritta del costruttore. In caso di pagamento dilazionato, il mancato pagamento anche di una sola rata consente al costruttore di esigere il saldo immediato del rimanente credito aumentato degli interessi maturati al tasso medio in vigore nel periodo. In caso di ritardato pagamento, il cliente sarà tenuto a corrispondere al termine della scadenza, interessi di mora così come stabilito dal D.Lgs 09.10.2002 n. 231.

7) DIVIETO DI AZIONE: Il cliente non può, per nessuna ragione, ritardare o sospendere i pagamenti dovuti a qualunque titolo, anche se fossero insorti reclami o contestazioni, né può promuovere o proseguire azioni giudiziarie di alcun genere se prima non abbia provveduto al pagamento nei termini e nei modi pattuiti.

8) CARATTERISTICHE TECNICHE: I dati e le caratteristiche tecniche citati in tutte le pubblicazioni ufficiali del costruttore fanno riferimento a valori nominali indicativi. Per specifiche necessità e su esplicita richiesta, il costruttore può mettere a disposizione schede tecniche di prodotto più dettagliate da cui si possono altresì dedurre i criteri di accettabilità interna dei prodotti. Il costruttore si riserva il diritto di apportare qualsiasi modifica senza preavviso; pertanto pesi, misure, prestazioni e quanto altro indicato non sono vincolanti ma solo indicativi.

9) GARANZIA: Il costruttore presta le garanzie di legge. La garanzia copre ogni difetto di costruzione del solo materiale prodotto dal costruttore, essa inoltre si limita alla riparazione o sostituzione dell'elettropompa o del pezzo riconosciuti difettosi presso gli stabilimenti del costruttore o quant'altri dallo stesso autorizzati. In nessun caso comunque la garanzia implica la possibilità di richiesta di indennità e si declina ogni responsabilità per danni materiali e corporali che venissero causati dalle macchine prodotte dal costruttore, sia diretti che indiretti. La garanzia decade: - Se la macchina è stata riparata, smontata o manomessa da persone non autorizzate dal costruttore. - Se il guasto è stato provocato da errori di collegamento elettrico od idraulico, da mancata o non adeguata protezione. - Se l'impianto o l'installazione delle macchine non è stato eseguito correttamente. - Se la macchina è stata assoggettata a sovraccarichi oltre i limiti di targa. - Se i materiali sono stati guastati a seguito del contratto con liquidi abrasivi o corrosivi comunque non compatibili con i materiali impiegati nella costruzione delle pompe. - Se i materiali sono avariati a seguito del naturale logoramento. - La macchina difettosa dovrà pervenire presso gli stabilimenti del costruttore in porto franco. Il costruttore si riserva l'insindacabile giudizio sulla causa del difetto e se lo stesso rientra nei casi previsti dalla garanzia. A riparazione avvenuta, la macchina sarà restituita in porto assegnato al cliente.

10) FORO COMPETENTE: Per eventuali controversie il foro competente sarà quello di Perugia anche se il pagamento è convenuto a mezzo tratta.

11) RICHIAMO AD ALTRE NORME: Per quanto non espressamente stabilito nei punti precedenti varranno le disposizioni di legge e le norme usuali e consuetudinarie del luogo in cui ha sede il costruttore vigenti in materia.

GENERAL SALES CONDITIONS

1) ORDERS: Any order sent to us, whether by our representatives or by letter, telephone or fax, will be considered definite only after our regular acceptance in writing.

2) DELIVERY: The terms indicated for delivery are not binding but subject to manufacturing factors and unforeseeable circumstances (trade unions unrest, breakdown of machinery, late delivery by our suppliers, general unavailability of raw materials, fire, flood or other forces majeure). Any delay which might occur will not give rise on the part of the purchaser of the right to annual the order or to claim damages.

3) TRANSPORT: Goods travel at the customer's risk even if the price is stated as carriage free. The vendor will not be liable for the underweight goods or damage caused during transit as the carrier is exclusively liable in such cases and it is to him that the receiving party must promptly address a right informative notice in writing to this to the dealer. After 8 days have passed from receipt of the goods, no claims are in any case admissible.

4) PRICES: The prices are to be understood as net of tax duties and may be changed without notice.

5) RIGHT OF PROPERTY: The goods property belongs to the manufacturer and it is not acquired by the customer until the complete payment is made for the goods, and any interest and costs involved. In case of payment not honoured, the goods will, on the manufacturer's express request, be promptly sent back to the stores in free port by manufacturer. In any case the manufacturer reserves the right to charge the customer with the cost of restoration and renewal of returned goods.

6) PAYMENTS: Payments must be effected at due dates and in the terms agreed at our Magione Headquarters (Perugia). Payment made to agents, representatives or others are not recognized even by bills unless there is an express written authority by the manufacturer. In case of payment by instalments the failure to pay even one instalment allows the manufacturer to require the balance immediately plus the interest accrued at the average rate in force for the period. In case of delayed payment, the customer will be obliged to pay at the expiration date, interests on arrears as establish by D. Lgs 09.10.2002 n. 231.

7) BLOCKAGE OF CLAIMS: The customer may not, for any reason, delay or suspend payments owed on any account even if claims or disputes have arisen, nor may he start or take legal action of any kind if he has not first paid by the terms and in the terms agreed.

8) TECHNICAL CHARACTERISTICS: The technical data and characteristics stated in all the manufacturer's official publications refer to indicative nominal values. For specific needs and on explicit demand, the manufacturer can provide detailed technical sheets from which the internal acceptance criteria of the product can be deduced. The manufacturer reserves the right to make any modification without prior notice. Therefore weights, dimensions, performances and any other stated issues are indicative only and not binding.

9) GUARANTEE: The manufacturer gives the guarantees provided by the Law. The guarantee covers every manufacturing defect only for the components/parts produced by the manufacturer: the Company also limits itself to the repair or replacement of the electric pump, or of the part recognized as being faulty, at the manufacturer's or other authorized premises. In no case however does the guarantee imply the possibility of claiming an indemnity and any liability is denied for damage to things or to the person caused by the manufacturer machines, whether directly or indirectly. The guarantee does not apply: - If the machine has been repaired, dismantled or tampered by person not authorized by the manufacturer. - If the breakdown has been caused by errors in connecting the electrical or hydraulic systems, or by the failure to provide protection or the provision of inadequate protection. - If the setting up of the machine or its electrical or hydraulic systems has not been correctly carried out. - If the machine has been subject to loads exceeding the ones within the label specifications. - If materials have been damaged due to contact with abrasive or corrosive liquids or which are in any way incompatible with the materials used in the manufacture of the pumps. - If the materials have deteriorated due to natural wear. The defective machine must be taken to the manufacturer's premises in free port. The manufacturer reserves the indisputable right to impute the cause of the defect and to ascertain whether it falls within the warrant cases at his full expenses. When the machine has been repaired it will be returned to the customer.

10) COMPETENT COURT: In case of any dispute the competent Court will be the one of Perugia even if the payment is by Bill of Exchange.

11) RECOURSE TO OTHER NORMS: As regards to other matters not expressly stated in the above points, the laws, norms and commercial customs in force at the place, where the manufacturer has its premises, will be applied.

CONDITIONS GENERALES DE VENTE

1) COMMANDES: Toute commande, faite par l'intermédiaire de nos agents, par lettre, par téléphone ou encore par télécopie, doit être considérée définie seulement après acceptation écrite de notre part.

2) LIVRAISON: Les délais indiqués pour la livraison ne nous engageant pas, mais ils sont subordonnés aux possibilités de fabrication et aux cas de force majeure (agitations syndicales, dégâts aux machineries, livraison différée de la part des fournisseurs, situations générales d'impossibilité de trouver les matières premières, incendies, inondations, ou d'autres causes de force majeure). Un retard éventuel ne peut pas déterminer, de la part de l'acheteur, l'annulation de la commande ni la prétention d'un dédommagement.

3) EXPEDITION: Les marchandises voyagent au risque et péril du commettant même si le prix est établi franco destination. Nous ne répondons pas des réclamations dues à faute de poids ni à avaries de voyage, étant responsable de cela uniquement et exclusivement le transporteur au quelle destinataire doit promptement dresser une réserve avant de retirer la marchandise et communiquer cela par écrit, pour information, même au cessionnaire. Après 8 jours à compter à partir de la date de réception des marchandises, aucune réclamation n'est acceptée.

4) PRIX: Les prix s'entendent nets des charges fiscales et peuvent être variés sans que le fabricant soit obligée de donner un préavis.

5) RESERVE DE PROPRIETE: La propriété des biens livrés reste au fabricant et ne passe pas au clients sinon après paiement intégral du prix, des intérêts et des frais dûs. En cas de défaillance, la marchandise sera livrée de nouveau, sur demande précise du fabricant, aux dépôts indiqués par le fabricant franco de port. De toute façon le fabricant se réserve la faculté de débiter au client les frais supportés pour la régénération et la mise à neuf du matériel rendu.

6) PAIEMENTS: Les paiements doivent être effectués à l'échéance et selon les formes convenues dans notre siège de Magione (PG). En cas de paiement en retard, ils seront appliqués les intérêts de retard dans la mesure du taux Euribor 3M +2%, sans la nécessité de la mise en demeure du acheteur. Les paiements faits à agents, représentants ou autres même si au moyen d'effets ne sont pas reconnus, sauf précise autorisation écrite de la part du fabricant. En cas de paiement échelonné, le non-paiement même d'un seul versement permet au fabricant d'exiger le solde immédiat du crédit restant augmenté des intérêts rapportés au taux moyen en vigueur dans cette période.

7) DEFENSE D'ACTION: Le client ne peut, pour aucune raison, différer ni suspendre les paiements dus à n'importe quel titre, même si des réclamations ou des contestations ont surgi. En outre, il ne peut ni intenter ni poursuivre aucune action en justice de n'importe quel genre, si, avant cela, il n'a pas pourvu au paiement dans les termes et les formes convenus.

8) CARACTERISTIQUE TECHNIQUES: Les données et les caractéristiques techniques citées dans toutes les publications officielles du fabricant se rapportent à des valeurs nominales indicatives. Sur demande et pour des nécessités spécifiques, le fabricant peut mettre à disposition des fiches techniques des produits détaillées par lesquelles on peut déduire aussi les critères de recevabilité technique interne des produits. Le fabricant se réserve le droit d'apporter n'importe quelle modification sans aucun préavis; par conséquent les poids, les mesures le performances et tout ce qui est indiqué ne sont pas contraignants mais simplement indicatifs.

9) GARANTIE: Le fabricant offre les garanties prévues par la loi. La garantie couvre n'importe quel défaut de fabrication exclusivement du matériel produit par le fabricant. En outre, elle s'entend dans les limites de la réparation ou substitution de l'électropompe ou de la pièce reconnue défectueuse dans les établissements du fabricant ou d'autres autorisés par le fabricant. De toute façon, la garantie ne comporte jamais la possibilité de demande d'indennité et le fabricant décline toute responsabilité pour des dommages matériels et physiques causés directement ou indirectement par des machines produits du fabricant. La garantie cesse: - Si la machine a été réparée, démontée ou manipulée par des personnes non autorisées par le fabricant. - Si l'installation ou la mise en fonction des machines n'ont pas été faites de façon correcte. - Si la machine a subi des surcharges dépassant les limites de plaque. - Si les matériels se sont abimés au contact de liquides abrasifs ou corrosifs, de toute façon non compatibles avec les matériels utilisés pour la constructions des pompes. - Si les matériels sont détériorés par l'usure naturelle. La machine défectueuse devra parvenir aux établissements du fabricant en franco de port. Le fabricant se réserve le droit de jugement sans appel sur la cause du défaut et d'établir s'il rentre dans les cas prévus par la garantie. La réparation faite, la machine sera rendue au client en port dû.

10) TRIBUNAL COMPETENT: En cas de différend, le tribunal compétent sera celui de Perugia, même si le paiement est convenu par traite.

11) RAPPEL A D'AUTRES NORMES: En ce qui concerne les aspects non expressément établis aux points précédents, les dispositions de la loi et les règlements usuels et coutumiers en vigueur en matière dans le lieu où le fabricant a son siège seront appliqués.



**Umbra[®]
Pompe**

Umbra Pompe s.r.l.
Magione (PG) - Italy
Tel. +39 075 8472250
Fax +39 075 8472252
www.umbrapompe.it
umbrapompe@umbrapompe.it

